



PYLONTECH

Lithium Ion Phosphate Energy Storage System PowerCube-H1/H2-V2 Operation Manual

Information Version: V1.0
5PMPA08-00130

This manual introduces PowerCube-H1/H2-V2 from Pylontech. PowerCube-H1/H2-V2 is a high voltage Lithium-Ion Phosphate Battery storage system. Please read this manual before you install the battery and follow the instruction carefully during the installation process. Any confusion, please contact Pylontech immediately for advice and clarification.

Menu

1. Safety	1
1.1. Symbol	1
1.2. Reference standards	4
2. System Introduction	5
2.1. System description	5
2.2. Specification	5
2.3. System Specifications	6
2.4. Battery Module Specification	7
2.4.1. H48050	7
2.4.2. H48074	8
2.4.3. Battery Module Front Interface	9
2.5. Control Module Specification	10
2.5.1. Control Module Front Interface	10
2.6. System Diagram	14
2.6.1. System Diagram via CAN	14
2.6.2. Diagram between Control Module and Battery Modules	16
3. Installation	17
3.1. Installation tools	17
3.2. Safety Gears	17
3.3. Working Environments	19
3.3.1. Cleaning	19
3.3.2. Temperature	19
3.3.3. Cooling System	19
3.3.4. Heating System	19
3.3.5. Grounding System	19
3.4. Package Items	20
3.4.1. List of the accessories in the package	20
3.4.2. DC Power Cable	21
3.4.3. Communication Cable	21
3.5. Mechanical and Electrical Installation	22
3.5.1. Installation Notes	22
3.5.2. Mechanical Installation of the battery rack	22
3.5.3. Mechanical Installation of the battery module	23
3.5.4. Mechanical Installation of the control module	23
3.6. Cable Connection	24
3.6.1. Caution	24

3.6.2. Grounding	24
3.6.3. Internal power and communication cable connection within Rack	25
3.6.4. Communication wiring connection of the master and slave control modules	26
3.7. Process of System Turning On	29
3.7.1. Notes	29
3.7.2. Detail Steps	29
3.8. Process of System Turning Off	32
3.9. Selection of the external disconnecting device	32
4. System Debug	33
5. Maintenance	34
5.1. Trouble Shooting	34
5.1.1. Before start up	34
5.1.2. During operation	34
5.2. Replacement of main component among the BESS	37
5.2.1. Replacement of Battery module	37
5.2.2. Replacement of Control module	38
5.3. Battery Maintenance	39
5.3.1. Voltage Inspection	39
5.3.2. SOC Inspection	39
5.3.3. Cables Inspection	39
5.3.4. Balancing	39
5.3.5. Output Relay Inspection	40
5.3.6. History Inspection	40
5.3.7. Shutdown and Maintenance	40
5.3.8. Recycle	40
6. Remarks	40
6.1. Storage	40
6.2. Capacity expansion	40
7. Shipment	41
Annex 1: Installation and System Turn ON Progress List	41
Annex 2: System Turn OFF Progress List	42

1. Safety

The PowerCube-H1/H2-V2 is a high voltage DC system, operated by authorized person only. Read all safety instructions carefully prior to any work and observe them at all times when working on with the system.

Incorrect operation or work may cause:





- Injury or death to the operator or a third party;
- Damage to the system hardware and other properties belonging to the operator or a third party.









Skills of Qualified Person

Qualified personnel must have the following skills:

- Training in the installation and commissioning of the electrical system, as well as the dealing with hazards;
- Knowledge of the manual and other related documents;
- knowledge of the local regulations and directives.

1.1. Symbol

	Danger	Lethal voltage! <ul style="list-style-type: none">● Battery strings will produce high voltage DC power and can cause a lethal voltage and an electric shock.● Only qualified person can perform the wiring of the battery strings.
	Warning	Risk of battery system damage or personal injury <ul style="list-style-type: none">● Do not pull out the connectors while the system is working!● De-energize from all multiple power sources and verify that there is no voltage.
	Caution	Risk of battery system failure or life cycle reduces.
	Symbol in label	Read the product and operation manual before operating the battery system!
	Symbol in label	Danger! Safety!

	Symbol in label	Warning electric shock!
	Symbol in label	Do not place near flammable material
	Symbol in label	Do not reverse connection the positive and negative.
	Symbol in label	Do not place near open flame
	Symbol in label	Do not place at the children and pet touchable area.
	Symbol in label	Recycle label.
	Symbol in label	Label for Waste Electrical and Electronic Equipment (WEEE) Directive (2012/19/EU)
	Symbol in label	The certificate label for EMC.
 <p>Type Approved Safety Regular Production Surveillance www.tuv.com ID 0000000000</p>	Symbol in label	The certificate label for Safety by TÜV Rheinland.



Danger: Batteries deliver electric power, resulting in burns or a fire hazard when they are short circuited, or wrongly installed.



Danger: Lethal voltages are present in the battery terminals and cables. Severe injuries or death may occur if the cables and terminals are touched.



Warning: Do not open or deform the battery module and control module;

Warning: Whenever working on the battery, wear suitable personal protective equipment (PPE) such as rubber gloves, rubber boots and goggles.



Warning: PowerCube-H1/H2-V2 system working temperature range: 0°C~50°C; Optimum temperature: 18°C~28°C. Out of the working temperature range may cause the battery system over / low temperature alarm or protection which further lead to the cycle life reduction as well as. It will affect the warranty terms as well.



Caution: Improper settings or maintenance can permanently damage the battery.

Caution: Incorrect inverter parameters will lead to the premature aging of battery.

1.2. Reference standards

No.	Description	Code
1	Safety Standard for Secondary Lithium Batteries	IEC62619:2022 IEC63056:2020
2	UN38.3 Safe Transport Standard Recommendations on the Transport of Dangerous Goods, Manual of Tests and Criteria	ST/SG/AC.10/11/Rev.7/Amend.1/Section 38.3
3	RED Standard Directive 2014/53/EU	EN 300 328 V2.2.2 EN 301 489-1 V2.2.3; EN 301 489-17 V3.2.4; EN IEC 61000-6-1:2019 EN IEC 61000-6-2:2019 EN 61000-6-3:2007+A1:2011 EN IEC 61000-6-4:2019
4	Electromagnetic Compatibility Regulations 2016 (UK SI 2016 No. 1091)	BS EN IEC 61000-6-1:2019 BS EN IEC 61000-6-2:2019 BS EN 61000-6-3:2007+A1:2011 BS EN IEC 61000-6-4:2019
5	Safety Standard for Electrical Devices Low Voltage Directive 2014/35/EU	EN 62477-1:2012+A11:2014+A1:2017+A12:2021
6	Safety Standard for Lithium Battery (Germany)	VDE-AR-E 2510-50:2017-05

2. System Introduction

2.1. System description

PowerCube-H1/H2-V2 is a high voltage battery storage system based on lithium iron phosphate battery, which is one of the new energy storage products developed and produced by Pylontech. It can be used to support reliable power for various types of equipments and systems. PowerCube-H1/H2-V2 is especially suitable for those application scenes which required high power output, limited installation space, restricted load-bearing and long cycle life.

PowerCube H1/H2-V2 Battery Energy Storage System			
Voltage Rating	System Type	Level 1	Level 2
		Battery Module	Control Module
1000V	PowerCube-H1-V2	H48050	SC1000-100S-V2
	PowerCube-H2-V2	H48074	

2.2. Specification



2.3. System Specifications

Product Type	PowerCube-H1-48/zzzV (zzz=240~864,in step of 48)	PowerCube-H2-48/zzzV (zzz=240~864,in step of 48)
Product Name	LFP Lithium Ion Energy Storage System	
Cell Technology	LiFePO4	
System Voltage	<1000V	
Battery System Capacity(kWh)	2.4 × n(where n = 5~18)	3.552 × n (where n = 5~18)
Battery System Voltage(Vdc)	48 × n (where n = 5~18)	
Battery Module Type	H48050	H48074
Battery Module Capacity(Ah)	50Ah	74Ah
Battery System Quantity(pcs)	n (where n = 5~18)	
Battery Module Capacity(kWh)	2.4	3.552
Battery Charge Upper-Voltage(Vdc)	54 × n (where n = 5~18)	
Battery Module Discharge Lower-Voltage(Vdc)	43.5 × n (where n = 5~18)	
Control Modue Type	SC1000-100S-V2	
Battery System Charge Current(Nominal)	25	37
Battery System Charge Current(Max)	50	74
Battery System Discharge Current(Nominal)	25	37
Battery System Discharge Current(Max)	50	74
Efficiency(@0.5C-rate)	96%	96%
Depth of Discharge	95%	95%
Communication	Modbus RTU/CAN/LAN	
Short circuit rating/Duration	<3000 2ms	
Protection Class	IP20	
Cooling Type	Nature	
Operation Temperature(°C)	0~50°C	
Storage Temperature(°C)	-20~60°C	
Humidity	5~95%	
Operation Cycle Life	5,000	
Operation Life(Years)	15+	
Product Certificate	IEC62619,IEC63056,RED,CE LVD,VDE2510-50,IEC62040-1	
Transfer Certificate	UN38.3	
Battery Module Dimension(W*D*H mm)	H48050 442× 390× 100	H48074 442×390× 132
Control Module Dimension(W*D*H mm)	SC1000-100S-V2 442× 390× 132	
Rack Dimension(W*D*H mm)	Rack1: 600×505×2130 (where n = 5~15) , and Rack2: 600×505×2130 (where n = 16~18)	Rack1: 600×505×2130 (where n = 5~12), and Rack2: 600×505×2130 (where n = 13~18)
Weight(kg)	Rack1: 77kg+ 24kg×n (where n = 5~15) Rack2: 68kg+ 24kg×n (where n = 16~18)	Rack1: 77kg+ 32kg×n (where n = 5~15) Rack2: 68kg+ 32kg×n (where n = 16~18)

2.4. Battery Module Specification

2.4.1. H48050



Product Type	H48050
Cell Technology	LiFePO4
Battery Module Capacity(kWh)	2.4
Battery Module Voltage(Vdc)	48
Battery Module Capacity(AH)	50
Dimension(W*D*H, mm)	442*390*100
Protection Class	IP20
Weight(kg)	24
Operation Life(Years)	15+
Operation Cycle Life	5,000
Operation Temperature(°C)	0~50
Storage Temperature(°C)	-20~60
Transportation Certificate	UN38.3

2.4.2. H48074



Product Type	H48074
Cell Technology	LiFePO4
Battery Module Capacity(kWh)	3.552
Battery Module Voltage(Vdc)	48
Battery Module Capacity(AH)	74
Dimension(W*D*H, mm)	442*390*132
Protection Class	IP20
Weight(kg)	32
Operation Life(Years)	15+
Operation Cycle Life	5,000
Operation Temperature(°C)	0~50
Storage Temperature(°C)	-20~60
Transportation Certificate	UN38.3

2.4.3. Battery Module Front Interface



Power Terminal +/-

To connect battery series power cables.

Status

Status light: to show the battery module's status (RUN ●, Alarm and Protection ●).

RS232 Terminal

Console Communication Terminal: (RJ45 port) follow RS232 protocol, for manufacturer or professional engineer to debug or service.

Link Port 0, 1

Link Port 0, 1 Communication Terminal: for communication between multiple serial battery modules and controller module.

Power Terminals

Power cable terminals: there are two pairs of terminals with same function, one connects to equipment, the other one parallels to other battery module for capacity expanding. For each single module, each terminal can achieve charging and discharging function.

For power cables uses AMPHENOL connectors. Must keep pressing the Lock Button during pulling the power plug.

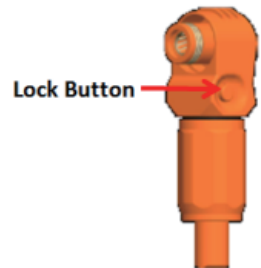

2.5. Control Module Specification

No.	Product Type	SC1000-100S-V2
1	Related Product	H48050/H48074
2	Controller Working Voltage	200~1000Vdc
3	System Operation Voltage(Vdc)	200~1000
4	Charge Current(Max.)(A)	80
5	Discharge Voltage(Vdc)	200~1000
6	Discharge Current(Max.)(A)	80
7	Self-consumption Power(W)	8
8	Dimension(W*D*H,mm)	442*390*132
9	Communication	Modbus RTU/CAN/LAN
10	Protection Class	IP20
11	Weight(kg)	9
12	Operation Life(Years)	15+
13	Operation Temperature(°C)	-20~65
14	Storage Temperature(°C)	-40~80
15	Product Certificate	TUV, CE

* Maximum current is the values only for controller, the current value of the system is based on the battery module

2.5.1. Control Module Front Interface

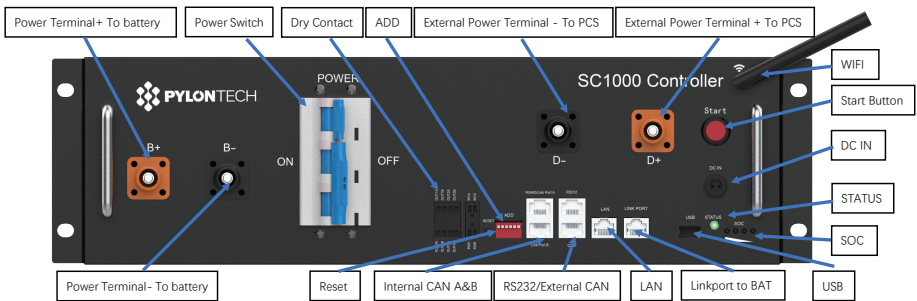

SC1000-100S-V2

Power Terminal B+/B-

To connect battery module power cables in series.

Power Switch



Switch the battery system's (control module and high voltage DC power) ON/OFF.

Caution: When the breaker is tripped off because of over current or short circuit, must wait after 30 minutes to turn on it again, otherwise may cause the breaker damage.

External Power Terminal D+/D-

Connect battery system with Power Conversion System.

Dry Contact Terminal

Dry Contact Terminal: provided 2 input and 4 output dry contact signal.

In/out	Function	Open and close state
In1	Internal Using ONLY	For wake up signal serial connection using ONLY.
In2	For wake up or For Emergency Stop signal**	Always close, when open will switch off the system.
Out1	Stop Charge	Always close, when open shall stop charge.
Out2	Stop Discharge	Always close, when open shall stop discharge.
Out3	Error	Always close, when open shall stop operation
Out4	Current Limit	Always close, when open shall limit current to $\leq 0.2C$ -rate

Reset

Reset Button: Long press this button to restart the battery system.

ADD

ADD Switch is a 6 bit dial switches to manually distribute the communication address of the battery system. Downward position is OFF, means "0". Upward position is ON, means "1". For battery controller, 1st bit to 5th bit is for address allocation, and the 6th bit dial switch support a 120 Ω resistance (Terminal Resistance), the upward position(ON) of the 6th bit means access the resistance, and the downward position(OFF) means no access resistance. The terminal resistance needs to be activated ON at the first and last node.



Start Button



Start function: press more than 5 sec until the buzzer rings, to turn on controller.

Black start function: when system turned on and during self-check process, press and hold the start button again for more than 10sec, and relay will close for 10 mins.



开机：长按至蜂鸣器响

Power on: Press and hold ≥ 5 sec till the buzzer rings

RS485(Link Port A and B)

RS485 Communication Terminal: (RJ45 RS485 Link port A) follow Modbus RTU protocol, for external communication between battery system and Power Conversion System.

In a multi-strings structure, these two ports (RJ45 RS485 Link port A & B) are used to connect the two control modules of the front and rear nodes.

LAN

Console Communication Terminal: (RJ45 port) follow Modbus TCP protocol, only used for communication between the master control module and upper controller.

RS232

Console Communication Terminal: (RJ45 port) follow RS232 protocol, for manufacturer or professional engineer to debug or service.

Link Port

Link Port Communication Terminal: (RJ45 port) for internal communication between multiple serial battery modules and control module.

Definition of RJ45 Port Pin

No.	CAN	RS485	RS232
1	---	---	---
2	GND	---	---
3	---	---	TX
4	CANH	---	---
5	CANL	---	---
6	---	GND	RX
7	---	RS485A	---
8	---	RS485B	GND

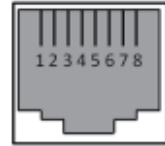

RJ45 Port



RJ45 Plug

DC IN

External 12VDC power supply for the Battery Controller.

Status and SOC Indicators

Status light: to show the battery module's status (RUN ●, Alarm ●).

SOC(Battery capacity indicator): 4 green lamps, each light represents 25% capacity.

Status and SOC Indicators Instructions									
Battery Status	Protection / Alarm / Normal	STATUS (green)	STATUS (red)	SOC 				Descriptions	
		●	●	●	●	●	●		
Shut Down		Off	Off	Off	Off	Off	Off	All off	
Sleep	Normal	Flash2	Off	Off	Off	Off	Off	Indicates Sleep Mode, to save the power.	
Idle	Normal	Light	Off	Off	Off	Off	Off	Indicates save power mode.	
	Alarm	Light	Off	Off	Off	Off	Off	Indicates the battery voltage or temperature is high or low.	
	Protection	Off	Light	Off	Off	Off	Off	Indicates the battery voltage or temperature is over or under.	
Charge	Normal	Light	Off	The highest capacity indicator LED flashes (flash 2), others lighting				The highest capacity indicator LED flashes (flash 2), others lighting, horse race lamp when SOC >= DODH;	
	Alarm	Light	Off						
	Protection	Off	Light	Off	Off	Off	Off	Stop charging, STATUS(red) lighting	
Discharge	Normal	Flash2	Off	Indicate based on capacity				Indicate based on capacity	
	Alarm	Flash2	Off						
	Protection	Off	Light	Off	Off	Off	Off	Stop discharging, STATUS(red) lighting	
Abnormal	Power On Fault	Off	flash 4	Off	Off	Off	Off	Stop charging/discharging, STATUS(red) lighting	
	Other Fault	Off	Light	Off	Off	Off	Off		
	STL Fault	Off	flash 2	flash 2				MCU self-check problem	
During start-up	Normal	flash 2	Off	flash 2				Power On Device	
BlackStart	Success	flash 5	Off	Off				Black Start Function	
	Fail	Off	flash 5	Off					
	Waiting	flash 5	Off	flash 5					
USB	Misc Update	flash 2	Off	flash 2	Off	Off	Off	Misc/Update(Before Forceup)	
	Event Update	flash 2	Off	flash 2	Off	Off	Off	Event/Update(M2SING)	
	History Update	flash 2	Off	flash 2				Off	History/Update(Updating)
	Info Update	flash 2	Off	flash 2				Off	Info/Update(Finished)

Note: The flashing instructions,
 flash 1 - 0.25s light / 3.75s off;
 flash 2 - 0.5s light / 0.5s off;
 flash 3 - 0.5s light / 1.5s off;
 flash 4 - 1s light / 1s off;
 flash 5 - 0.1s light / 0.1s off;

WIFI

Support for the Cloud platform functions.

Manufacturer: Pylon Technologies Co., Ltd.

Address: Plant 8, No.505 Kunkai Road, JinXi Town, 215324 Kunshan City, Jiangsu Province, PEOPLE'S REPUBLIC OF CHINA

Importer: XXXX (Located in installed country)

Address: XXXX (Located in installed country)

Wireless maximum output power: 20dBm

Operating frequency: 2412-2472MHz

Gain of antenna: Max 3dBi

Modulation system:

DBPSK/DQPSK/CCK(DSSS)

BPSK/QPSK/16QAM/64QAM(OFDM)

Modulating Repetition:

1Mbps/2Mbps/5.5Mbps/11Mbps(DSSS)

6Mbps/9 Mbps/12 Mbps/18 Mbps/24 Mbps/36 Mbps/48 Mbps/54 Mbps(OFDM)

MCS0~MCS7(802.11n 20MHz)

MCS0~MCS7(802.11n 40MHz)

Channel spacing:5MHz

Type of antenna: 2.4G IPEX-SMA Antenna

USB

USB is used for product updating and data downloading.

2.6. System Diagram

2.6.1. System Diagram via CAN

Multiple battery string parallel connection via CAN communication among BMSs diagram (battery string qty. ≤ 6 sets). The Battery Controller with ADD address 1 is the master and all remaining Battery Controllers are the slave. The external interface is only valid on the Battery Controller with ADD address "1".



Caution: When an MBMS does not exist, one of the V2 version control modules can be used as a battery control core to communicate externally with the PCS and internally to control the other control modules (V2 version or V1 version). When both V2 and V1 versions of the control module exist, the V2 version of the control module must be used as the master.

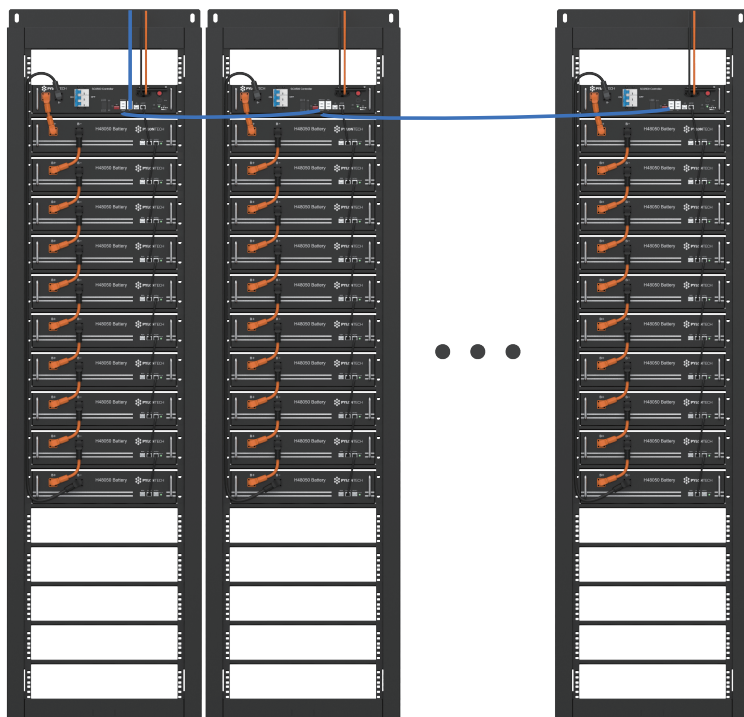
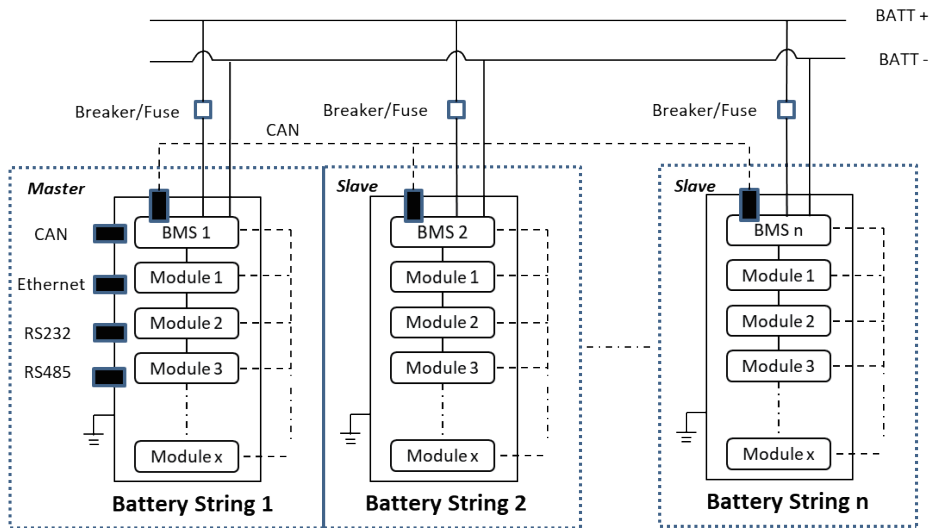

2.6.2. Diagram between Control Module and Battery Modules

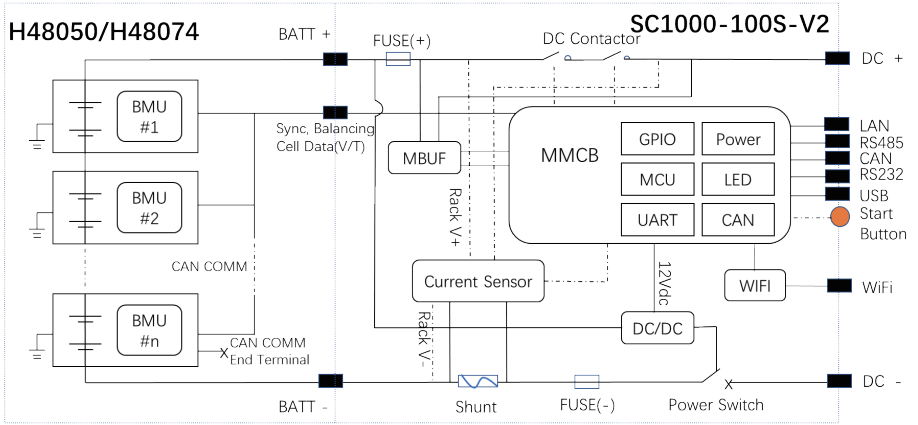

3. Installation

Please check every installation step in detail at <Annex 1: Installation and System Turn ON Progress List> during the installation.

3.1. Installation tools

The following tools are required to install the battery pack:

 Wire Cutter	 Crimping Modular Plier	 Wire Cutter
 Screw Driver Set	 Electric Screw Driver	 1000VDC Multimeter
 Adjustable Wrench	 Sleeve Piece	

Note

Use properly insulated tools to prevent accidental electric shock or short circuits. If insulated tools are not available, cover the entire exposed metal surfaces with available insulated alternatives, except their tips, with electrical tapes.

3.2. Safety Gears

It is recommended to wear the following safety gear when dealing with the battery pack.

 Insulated gloves	 Safety goggles	 Safety shoes
--	--	--

Torque Requirements

Console Communication Terminal: (RJ45 port) follow RS232 protocol, for manufacturer or professional engineer to debug or service.

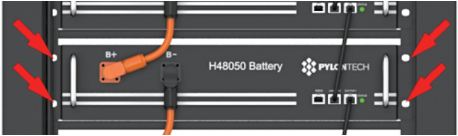
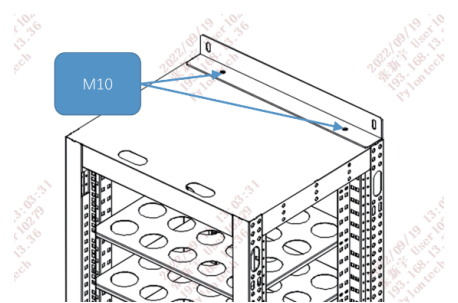
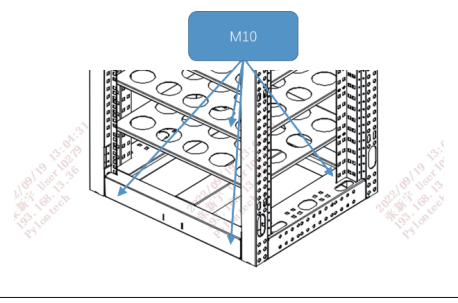
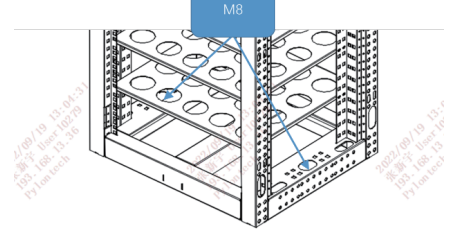
No.	Position	Torque(N.m)	Picture
1	Module fixation	6.0-7.7	
2	Rack top L-type strip (optional)	30-40	
3	Rack bottom fixation	30-40	
4	Grounding bolts	12-13	

3.3. Working Environments

3.3.1. Cleaning



The battery system has high voltage connectors. The clean condition will cause the isolation characteristic of the system.

Before installation and system working must clean the dust and iron scurf to keep the environments cleaning. And the environment must have certain anti-dust ability.

The system after long term running must check the humidity and dust cover or not. If heavy dust cover with high humidity on the system should stop the system running and make clean specially for the high voltage connectors.



Danger: the power cables and plugs still have high voltage DC power from serial connected battery modules (battery module can't be turned off), must be careful to handle the Power Plugs.

3.3.2. Temperature

PowerCube-H1/H2-V2 system working temperature range: 0°C ~ 50°C; Optimum temperature: 18°C ~ 28°C.



Caution: Out of the working temperature range may cause the battery reduces the cycle of life even cause the battery system over / low temperature alarm or protection.

3.3.3. Cooling System

The environment must be equipped with cooling system.



Caution: Out of the working temperature range may cause reduction of the cycle of life of the battery even trigger the battery system over / low temperature alarm or protection.

3.3.4. Heating System

The environment must be equipped with heating system. If the environment is lower than 0°C, the heating system at first must be turned on.



Caution: Out of the working temperature range may cause reduction of the cycle of life of the battery even trigger the battery system over / low temperature alarm or protection.

3.3.5. Grounding System

The environment must be equipped with heating system. If the environment is lower than 0°C, the heating system at first must be turned on.



Before the battery installation be sure the grounding point of the basement is stable and reliable. If the battery system is installed in an independent equipment cabin (e.g. container), make sure the grounding of the cabin is stable and reliable.

The resistance of the grounding system must be $\leq 100 \text{ m}\Omega$

3.4. Package Items

3.4.1. List of the accessories in the package

Item	Type	Quantity	Description	Notes
A1	Power Cable + (Battery Module and Control Module Serial Connection)	1pcs/control module	Orange/0.16m/4AWG/2 Orange Surlok Terminal	
A2	Power Cable - (Battery Module and Control Module Serial Connection)	1pcs/control module	Black/2m/4AWG/2 Black Surlok Terminal	
A3	Power Cable (Between the Battery Modules)	1pcs/battery module	Orange/0.18m/4AWG/1 Orange & 1 Black Surlok Terminal	
A4	External Power Cable +	1pcs/control module	Power Cable/Orange/2m/4AWG/SURLOK Terminal/50-8 ring terminal (BMS 'D+' to PCS)	
A5	External Power Cable -	1pcs/control module	Power Cable/Black/2m/4AWG/SURLOK Terminal/50-8 ring terminal (BMS 'D-' to PCS)	
B1	Battery Cascade Communication Cable (0.18m)	1pcs/battery module	Black/0.18m/8 Core Super 5th Class Twisted-pair Wire/RJ45	
B2	External Battery CAN Communication Cable (direct)	1pcs/system	Black/3.5m/Super 5th Class Twisted-pair Wire/2 RJ45 terminal	

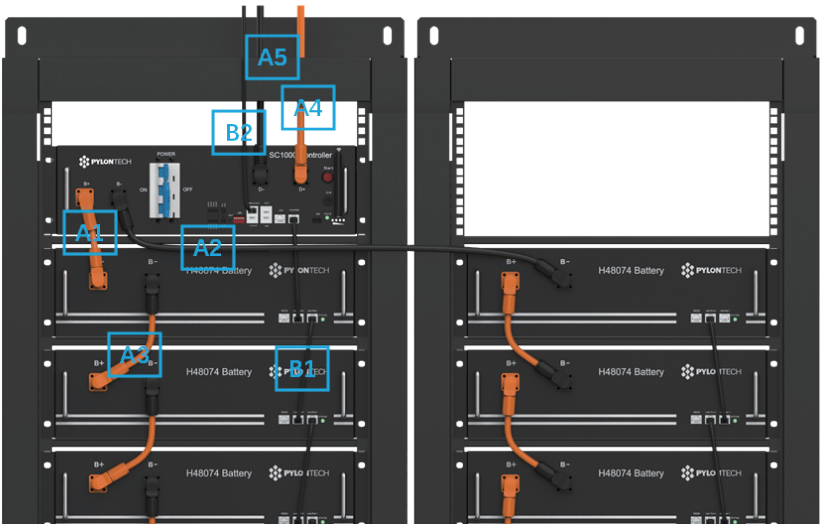

3.4.2. DC Power Cable

A1	Power Cable + (Battery Module and Control Module Serial Connection)	Orange/0.16m/4AWG/2 Orange Surlok Terminal	1pcs/control module
A2	Power Cable - (Battery Module and Control Module Serial Connection)	Black/2m/4AWG/2 Black Surlok Terminal	1pcs/control module
A3	Power Cable (Between the Battery Modules)	Orange/0.18m/4AWG/1 Orange & 1 Black Surlok Terminal	1pcs/control module
A4	External Power Cable +	Power Cable/Orange/2m/4AWG/SURLOK Terminal/50-8 ring terminal (BMS 'D+' to PCS)	1pcs/control module
A5	External Power Cable -	Power Cable/Black/2m/4AWG/SURLOK Terminal/50-8 ring terminal (BMS 'D-' to PCS)	1pcs/control module

3.4.3. Communication Cable

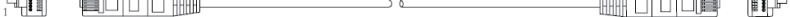
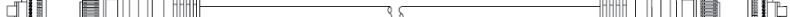
B1	Battery Cascade Communication Cable (0.18m)	Black/0.18m/8 Core Super 5th Class Twisted-pair Wire/RJ45	1pcs/battery module
			
B2	External Battery CAN Communication Cable (direct)	Black/3.5m/Super 5th Class Twisted-pair Wire/2 RJ45 terminal	1pcs/control module
			

3.5. Mechanical and Electrical Installation

3.5.1. Installation Notes



Warning: The battery rack is IP00. It must be installed in a restricted access area;

Warning: The PowerCube-H1/H2-V2 is high voltage DC system, operated by qualified and authorized person only.

3.5.2. Mechanical Installation of the battery rack

If without handling tools must have more than 4 men to handling with it.

The rack must be fixed on the basement and carriage on the wall with M10 screws.

Battery rack basement holes bitmap (unit: mm):

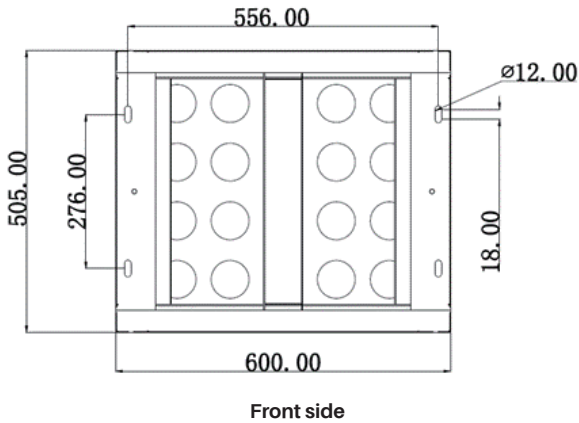

Battery rack wall fixed holes bitmap (unit: mm):

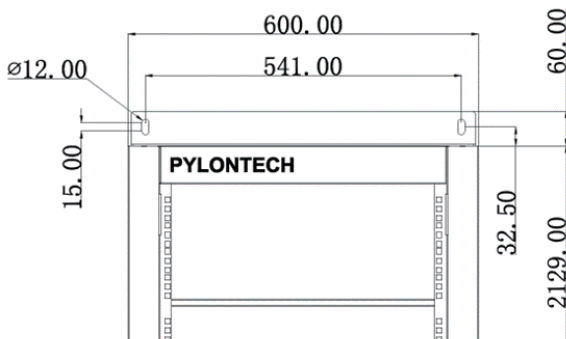

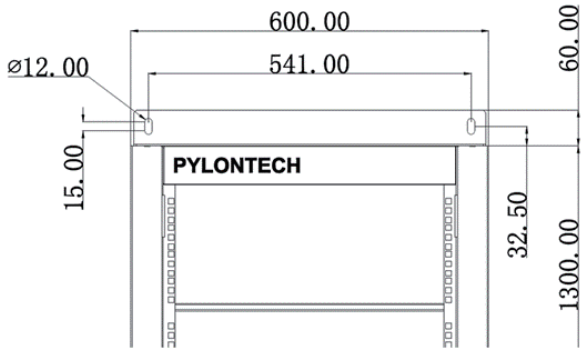

3.5.3. Mechanical Installation of the battery module

Single battery module is 24/32kg. If without handling tools must have more than 1 man to handling with it.

Install the buckle nuts. The position of nuts must meet the position of the battery modules.

Install the all battery modules in. Each module uses 4 screws to fix.



3.5.4. Mechanical Installation of the control module

Install the buckle nuts. The position of nuts must meet the position of the control module (BMS).

Install the control module (BMS) in. Each module uses 4 screws to fix.

3.6. Cable Connection

3.6.1. Caution



Danger: The battery system is high voltage DC system. Must make sure the grounding of the rack is stable and reliable.

Danger: All the plugs and sockets of the power cables must be orange to orange and black to black. Otherwise it will cause personal injury.



Danger: No short circuit or reserved connection of the battery system's anode and cathode.

Caution: Wrong communication cables connection will cause the battery system failure.

3.6.2. Grounding

The PowerCube-H1/H2-V2 modules' grounding is based on metal directly touch between the module's surface and rack's surface. So it doesn't need grounding cables at all. If it uses normal rack, it should remove the paint at the corresponding grounding point.

Rack Grounding:

If there is a grounding metal frame outside the rack, for example, the metal angle steel frame at the bottom of the container, the fix hole of the fix frame can be fixed directly with the metal frame of the container. Then through the grounding of the container to ensure reliable grounding.

The cable shall be copper with yellow-green color.

If want to connect the ground cable, it can be connected to the M8 grounding bolt on the frame base. Grounding cable must $\geq 10\text{AWG}$.

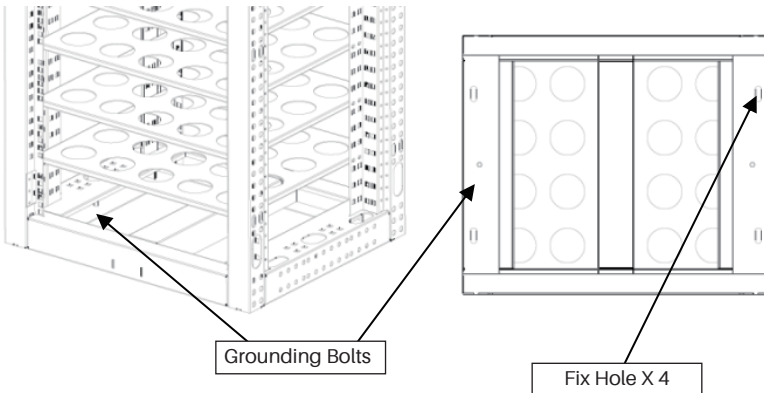

3.6.3. Internal power and communication cable connection within Rack

Note: Power cable uses water-proofed connectors. It must keep pressing this Lock Button during pulling out the power plug.

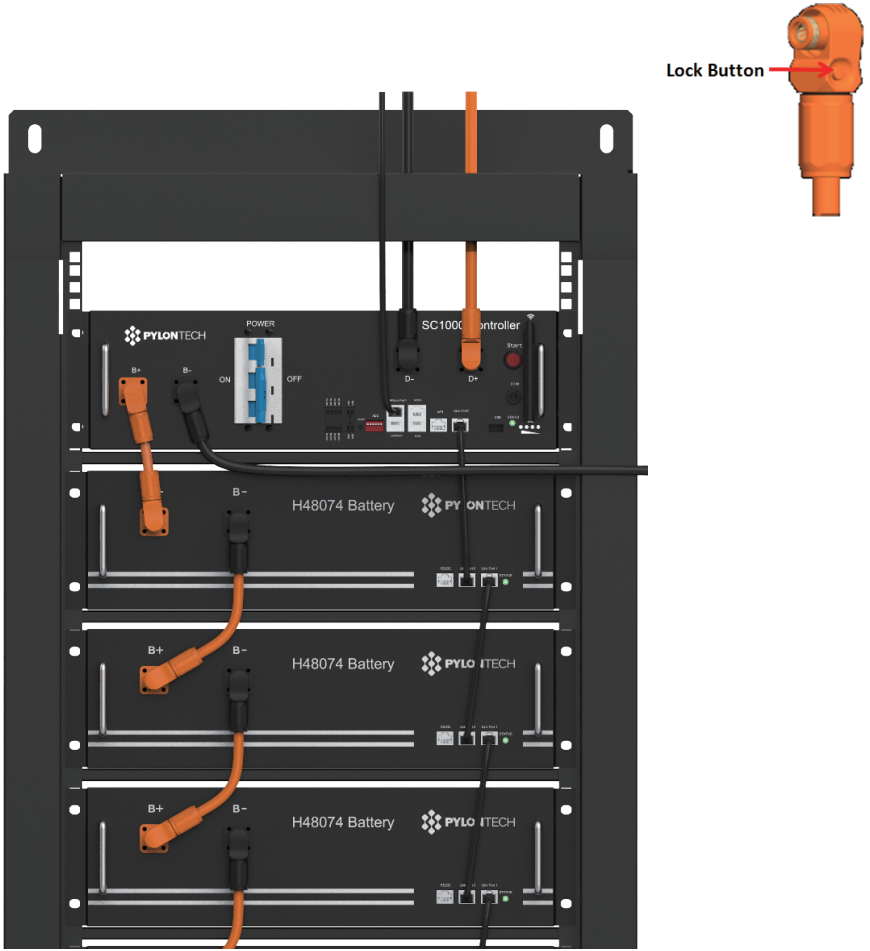

3.6.4. Communication wiring connection of the master and slave control modules

3.6.4.1. For single group communication wiring connection to inverter/upper controller

The communication cable shall connect follow below diagram.

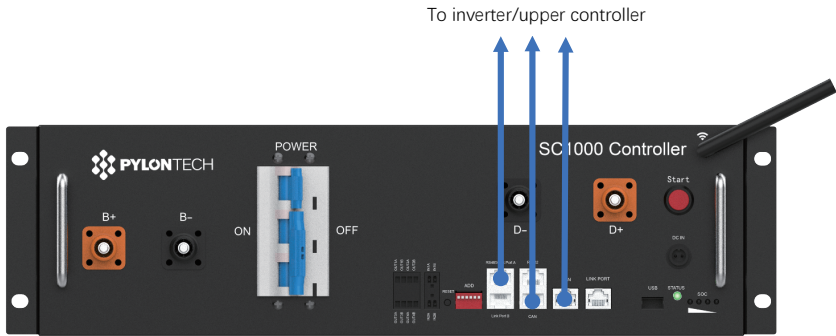

The ADD address shall set follow table,

Table of the control module ADD address setting for Single-group							
CAN Address	Address dial bit						Master or slave relationship
	1	2	3	4	5	6(Terminal Resistance)	
1						No requirement.	Master

3.6.4.2. For Multi-groups communication wiring connection



With SC1000-100S-V2, there **DONOT** need a MBMS for multi-groups operation.

For the existing installation (with old SC1000-100S) capacity expansion or BMS replacement activity, please **REMOVE** the MBMS and add on the SC1000-100S-V2 at the master position for further communication with existing inverter directly.

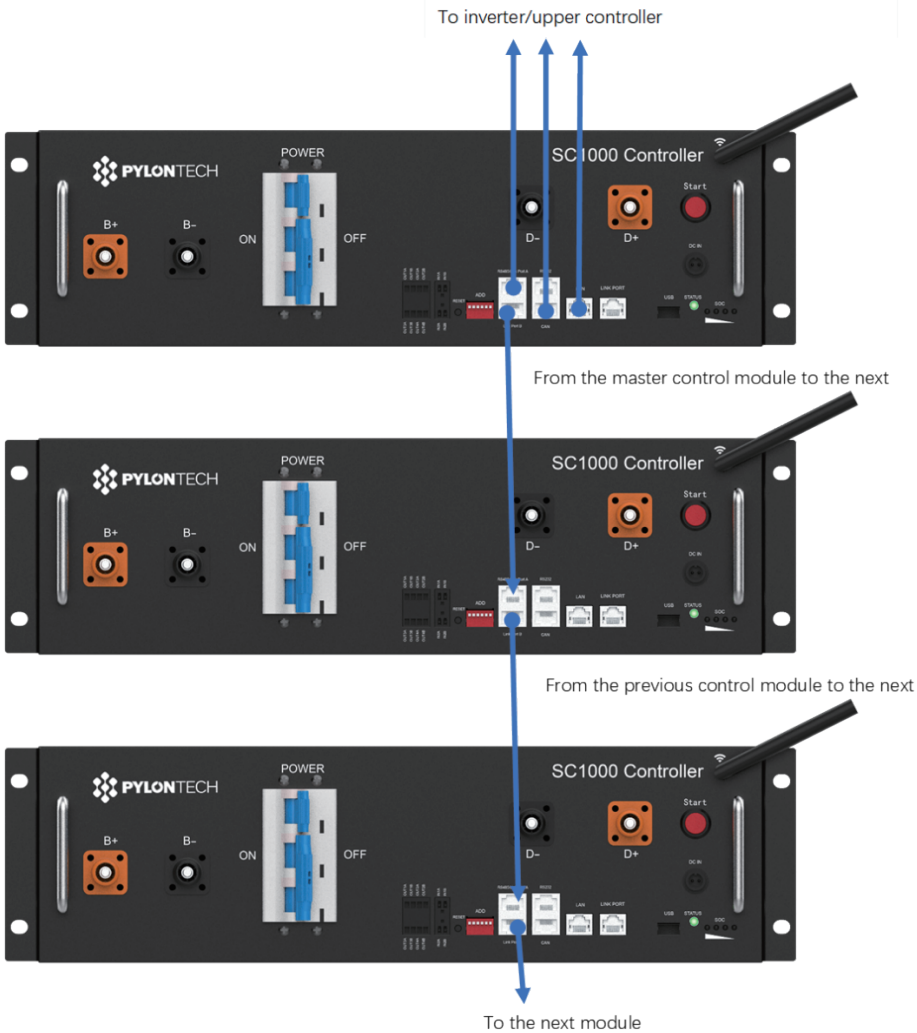
The communication cable shall connect follow below diagram, from the first BMS 'Link Port B' to the second BMS 'RS485 / Link Port A', from the second BMS 'Link Port B' to the third BMS 'RS485 / Link Port A', all the way to the last BMS 'RS485 / Link Port A'. The BMS with 'RS485 / Link Port A' **EMPTY** is defined as the master BMS, and further communication with the inverter.

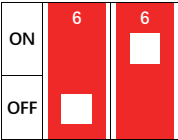
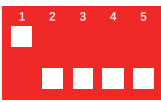
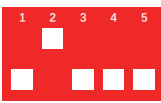

The ADD address shall set follow table

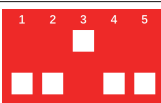
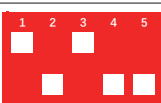
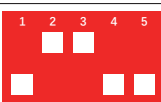
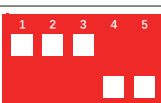
Table of the control module ADD address setting for Multi-strings							
CAN Address	Address dial bit					6(Terminal Resistance)	Master or slave relationship
	1	2	3	4	5		
0						 <p>The terminal resistance needs to be activated ON (upward) at the first(master control) and last node(the last slave control), when multiple controllers are connected in parallel.</p>	Invalid
1							Master
2							Slave
3							Slave
4							Slave
5							Slave
6							Slave
7							Slave

The ADD of each control module must be set different, setting it to the same will indicate a fault. The address range must be set to 1-7, other addresses will not be recognized.

Note

When both V1 and V2 versions of the control module are present in the BESS, the V2 version of the control module must be the master.

3.7. Process of System Turning On

3.7.1. Notes



Double check all the power cables and communication cables. Make sure the voltage of the PCS is same level with the battery system. Check all the power switch of every battery system is OFF.



Warning: The master control module must be turned on after other slave control modules self-check finish.

Warning: The external switch or breaker between PCS and battery string must be off before the battery system powers on.

3.7.2. Detail Steps

3.7.2.1. Switch the external power or inverter/PCS on, to make sure all the power equipments can work normally.

3.7.2.2. Turn on the control module

Operation Overview of multi-control-modules parallel operation,

- Turn on the 1st Slave control module of battery string;
- Turn on the 2nd Slave control module, it must be operated after the first control module self-check is successful.
- From the 1st Slave control module to the last Slave control module one by one;
- Turn on the Master control module at last after all slave control modules self-check is finished.

Operation steps for BMS controller as follows,

- Turn on the "POWER SWITCH":

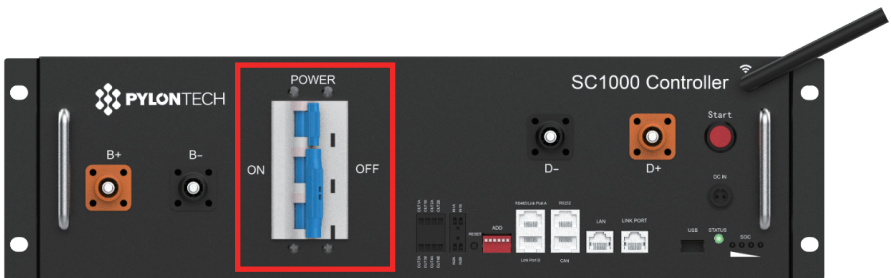

Caution: The time interval between every time switch OFF/ON the "Power Switch" shall >3 minutes.

Caution: When the breaker is tripped off because the system has over current or short circuit, must after 30mins to turn on it again, otherwise may cause the breaker damage.

- Turn on the “Start Button”:

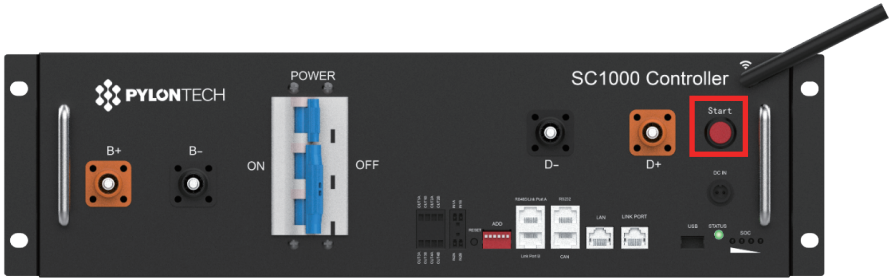

Press and hold the Start Button for more than 5 seconds until the buzzer rings, the LED indicator on front panel will light on if the start-up is successful.



开机：长按至蜂鸣器响
Power on: Press and hold ≥ 5 sec till the buzzer rings

3.7.2.3. Control Module Self-test and Start Process:

The battery string’s system will check by itself, if it works normally the battery string system will go to the self-check mode.

If the BMS and all battery modules are working normally, every status LED will be lighting green, that means self-check is passed. Normally the self-check will be finished within 30sec.

If long press the start button again within 30 seconds during BMS self-check, the “STATUS” lamp will flash green, it is to remind that the black start function is activated within 30 seconds for 10min.

If there is no communication from upper equipment because the communication is off, the “STATUS” lamp will light red after 30sec. That doesn’t mean failure existed, it means this battery string is OK when the external communication is off.



Warning: If it has failure during the self-check, must debug the failure then it can start next step.

If the “STATUS” lamp shows red from beginning, it means has failure in the battery string, the Power Relays in BMS will switch ON, must debug at first.



Caution: During first time power on, the system will require to do fully charge progress for SOC calibration purpose.

Caution: The whole Battery Energy Storage System (BESS) after installation or reuse the BESS when it is not used for a long time, user should charge it to full at first. There will be a regularly fully charge requesting during continuous operation as well, it will be handled automatically by the communication between BESS and external device.

3.7.2.4. Black Start

If long press the start button 30 seconds AFTER power on. The "STATUS" lamp will become green.

When the black start function is enabled, "STATUS" lamp remains red, it means the black start function is failed to active, it needs long press start button again. System will close relay and output for 10mins.



Warning: if the black-start function is enabled, the terminal of D+ and D- will be electricity dangerous with high DC voltage output.

3.7.2.5. Pre-charge function (Soft start)

The BMS has Pre-charge function. In each parallel operation, Pre-charge function will work.

If the pre-charge failure, it will retry the function after 30 seconds. Pre-charge failed for 3 consecutive times, the battery system will be **Pre-charge error**.



Warning: **DONOT** operate the system restart repeatedly when the **Pre-charge error** exists. The power connection (D+,D-) may be short circuit.

3.7.2.6. Description of the parallel connection of battery control modules

The first installation should do full charging progress.

After the Master controller has communicated with each slave BMS, it will run parallel operation. It will begin from lowest voltage battery string to do the parallel operation during the charging.

If the status LED of BMS turns to green, it means this battery string is in parallel operation.

When the voltage difference between strings is lower than the default parameter, the battery string will do the parallel operation. Then the power relays in BMS will switch ON after 30 seconds. The "STATUS" lamp of the BMS will light green;

When the voltage difference between strings is higher than the default parameter, the battery string will NOT do the parallel operation, the "STATUS" lamp of the BMS will light red, but it is normal; Such battery string will be paralleled in during charging or discharging stage automatically.



Note: If there is no communication between master controller and upper controller, the battery system can't work normally. External device should communicate with battery system through LAN, CAN or RS485. Otherwise maybe cause battery system work abnormally.

Caution: During first time power on, the system will require to do fully charge progress for SOC calibration purpose.



Caution: The whole Battery Energy Storage System (BESS) after installation or reuse the BESS when it is not used for a long time, user should charge it to full at first.

There will be a regularly (3 month) fully charge requesting during continuous operation as well, it will be handled automatically by the communication between BESS and external device.

3.8. Process of System Turning Off

When failure or before maintenance service, must turn the battery system off:

- (1) Soft-off the PCS through PCS's control panel.
- (2) Turn off the switch between PCS and battery strings (PowerCube-H1/H2-V2), or turn off the power switch of PCS, to make sure no current transmission through BESS and PCS.
- (3) Turn off the "Power Switch" of all the BMS.
- (4) Turn off the "Power Switch" of the MBMS. If the battery system configures only single control module and battery modules without MBMS, then ignore this operation step.
- (5) Turn off the UPS if configured.

The UPS can turn on if have equipment must keep running. Otherwise suggest turn off the UPS to save power.



Caution: Before change the battery module for service, must charge/discharge the replaced battery to same voltage as the other modules in the system. Otherwise system needs long time to do the balance for such replacement module.



Warning: Do not turn off the "Power Switch" during normal running condition. Otherwise it will cause this battery string current surge by another battery strings. If turned off the "Power Switch" in normal running condition, it must first turn off the PCS.

3.9. Selection of the external disconnecting device

A disconnecting device is **REQUIRED** between the battery system and the inverter. The conditions for selection are as follows.

1. Voltage level: 1000V DC, DO NOT use AC disconnecting device.
2. User can choose between a circuit breaker or an 'isolator + fuse' combination.
3. One set of disconnecting device per each BMS.
4. The selection of the disconnecting device current is based on 1.2 times the rated current of the control module.
5. $I_{cu} \geq 10kA$

Note

After installation, DO NOT forget to register online for full warranty:

www.pylontech.com.cn/service/support

4. System Debug

This system debug is for BESS system (Battery Energy Storage System). BESS system can't do the debug itself. It must operation with configured UPS, PCS and EMS system together.

Debug Step	Content
Prepare of debug.	<p>Turn on the BESS system, refer to chapter 3. Before turn on the whole BESS system turn on the load is not allowed!</p> <p>Remark: Except the BESS, if other equipments have its own system turn on step, must follow its own system operation manual.</p>
System function test.	<p>Each component system debug:</p> <p>Power supply Check if the External Power Supply if configured (e.g. UPS) is working normally.</p> <p>Communication Test: Check the communication between the BESS system and communicated devices normal or not, has alarm or not.</p> <p>Power Conversion System Test: Before conjoint test must test the Inverter System turn on progress at first. And check the parameters meet BESS requirement or not.</p> <p>BESS Test: Charge/Discharge test; Test stop charging, stop discharging, current limiting functions, etc.</p> <p>Caution: Before turn on the BESS system must setup all the parameters of the power inverter and EMS at first.</p>
Monitor function test. (If configured.)	<p>Check whether the data of the BESS system is showing on the monitor system normally.</p>
EMS conjoint test (If configured.)	<p>If the EMS system has running monitor requirements, check if the BESS system is following EMS instructions.</p>
Trial operation test.	<p>After the system debugged, run the system a period as test (testing with low load), to test the high voltage DC system is fit for the contract.</p>

5. Maintenance



Danger: The PowerCube-H1/H2-V2 is a high voltage DC system, operated by qualified and authorized person only.



Danger: Before check the failure, must check all the cables connection and the BESS system can turn on normally or not.

5.1. Trouble Shooting

5.1.1. Before start up

Failure Mode	Possible Reason	Solution
Battery system DO NOT start up until correct wiring connection and start up procedure	Power cable issue	1. Check the wiring connection and connectivity of the power cables.
	Internal cable issue	2. Open BMS case, check the connectivity and reliability of the internal power supply cable.
	PMU issue	3. Open BMS case, use multimeter check PMU 12Vdc output and CMU LEDs. If neither is on, please swap the PMU.
	Other error	4. If problem remain, contact Pylontech service engineer.

5.1.2. During operation

The 'Failure Definition' and 'Failure Mode' column is reference from Pylontech Modbus protocol Appendix IV Error code 1 bit to present.

Failure Type	Failure Definition	Possible Reason	Solution
Hardware	voltage sensor error (Bit0)	1.Sensor cable issue 2.Sensor connection issue 3.BMU issue	1.Change the RED LED module's BMU 2.Check the voltage sensor cable connect between BMU and battery pack of the connectivity 3. Change the RED LED module. 4.If problem remain, contact Pylontech service engineer.
Hardware	temperature sensor error (Bit1)	1.Sensor cable issue 2.Sensor connection issue	1.Change the RED LED module's BMU 2. Check the temp. sensor cable connect between BMU and battery pack of the connectivity 3. Change the RED LED module. 4.If problem remain, contact Pylontech service engineer.

Failure Type	Failure Definition	Possible Reason	Solution
Comm. and hardware	Internal Comm. ERR (Bit2)	Communication offline between module and BMS	<ol style="list-style-type: none"> 1. Check the connectivity and reliability of the comm. cable between BMS and battery modules. 2. Restart 3.If problem remain, contact Pylontech service engineer.
External	DC OV ERR input over voltage error (Bit3)	D+ D- voltage extremely higher than battery system voltage	Check external inverter's voltage whether match with the battery system or not.
External	Input RV Err (Bit4)	D+ D- reversely connected	Check the external power cables of the polarity and connection
Hardware	Relay Error (Bit5)	<ol style="list-style-type: none"> 1.Start-up procedure problem 2. Relay adhesion 3. Relay damage 	<ol style="list-style-type: none"> 1. Completely switch off inverter and battery system. Make sure DCBUS has no voltage. 2. Switch on each BMS first before switch on the MBMS. After the battery system finish self-test (require ~2mins), switch on the inverter. 3. Change the relay or BMS. 4.If problem remain, contact Pylontech service engineer.
Battery cell	Battery damage error (Bit6)	Battery cell voltage measured at <2.0V	<ol style="list-style-type: none"> 1. Restart 2. Swap out the RED LED module 3. Use multimeter to measure the battery module power terminal voltage, if is the same as the BMS reading value, then it's a true cell damage. Otherwise please swap the BMU of the module.
Hardware	Shutdown circuit error (Bit7)	Cannot completely switch off the system during self-protection	<ol style="list-style-type: none"> 1.Change PMU 2.If problem remain, contact Pylontech service engineer.
Comm. and hardware	BMIC error (Bit8)	Sensor chip error	<ol style="list-style-type: none"> 1.Restart 2.If observed a module LED is off, try to bypass the module on both comm. and power side and see whether rest modules' LED could be on and green. If so, then please change the BMU of the bypassed module. If not, further bypass the next LED off module and repeat the process. 3. If problem remain, contact Pylontech service engineer.
Comm. and hardware	BMS Internal bus error (Bit9)	CMU internal error or I2C issue	<ol style="list-style-type: none"> 1. Restart 2. Change the current measurement board 3. Change the CMU or BMS. 4.If problem remain, contact Pylontech service engineer.

Failure Type	Failure Definition	Possible Reason	Solution
Self-test	Self-test volt error (Bit10)	Battery cell voltage measurement mismatch with DCBUS voltage measurement	<ol style="list-style-type: none"> 1.Restart 2.Check the connectivity and reliability of the power and comm. cable by reconnection. 3. Swap the current measurement board or BMS 4.If problem remain, contact Pylontech service engineer.
Self-test	Safety check failure (Bit11)	Chip self-test failed	<ol style="list-style-type: none"> 1.Restart 2.If problem remain, contact Pylontech service engineer.
External	Emergency stop (Bit13)	Command by external device via dry contactor	Command by external device, not an error actively report by Battery system.
Self-test	Self-test module detecting amount error (Bit14)	Self-test failed	contact Pylontech service engineer.
Self-test	Self-test module coulomb error (Bit15)	Self-test failed	contact Pylontech service engineer.
Self-test	Self-test module Initial Error (Bit16)	Self-test failed	<ol style="list-style-type: none"> 1. Restart 2.If problem remain, contact Pylontech service engineer.
Comm. and hardware	Communication error between master and slave BMS (Bit17)	<ol style="list-style-type: none"> 1. Battery string(s) over-discharged 2. BMS CMU error 	<ol style="list-style-type: none"> 1. Check whether the battery string(s) has been overdischarged or not via multimeter. 2. Check the comm. cables between master and slave BMS, make sure the cable is 8PIN pin – pin CAT5 Ethernet cable. If BMS and MBMS is communication via CANBUS (no Ethernet switch), make sure the CANBUS physical length is less than 12m. Restart the system. 3. Reverse sequence connect the comm. cable between the BMSs and change the ADD address settings. Restart the system. 4. Change the BMS CMU or BMS. 5. If problem remain, contact Pylontech service engineer.

Failure Type	Failure Definition	Possible Reason	Solution
Comm. and hardware	BMU Internal bus error (Bit18)	BMU internal error	<ol style="list-style-type: none"> 1.Change the BMU of the RED LED module. 2.If problem remain, contact Pylontech service engineer.
hardware	Current IC Error (Bit22)	current measurement board error	<ol style="list-style-type: none"> 1. Restart 2. Change the current measurement board 3. Change the CMU or BMS. 4. If problem remain, contact Pylontech service engineer.
hardware	Pre-charge error. (Bit23)	Pre-charge circuit error.	<ol style="list-style-type: none"> 1. Check the external power cables of the polarity and connection 2. Change the pre-charge circuit board 3. If problem remain, contact Pylontech service engineer.

5.2. Replacement of main component among the BESS



Danger: The PowerCube-H1/H2-V2 is a high voltage DC system, operated by qualified and authorized person only.

Danger: Before replacing the main component user must shut off the maintenance battery string's power. Must confirm the D+ and D- terminal are without power. The turn off progress refer to chapter 3.8

5.2.1. Replacement of Battery module

5.2.1.1 Use a charger to charge the new battery module and existing module to full (SOC 100%)

5.2.1.2 Turn off the whole battery string's power. Must confirm the D+ and D- terminal are without power. The turn off progress refer to chapter 3.8

5.2.1.3 Pull out the Plug of Power Cable +/- . Pull out the plug of communication cable.

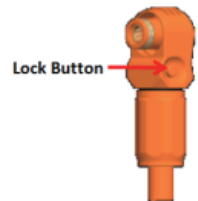

Danger: the power cables and plugs still have high voltage DC power from serial connected battery modules (battery module can't be turned off), must be careful to handle the Power plugs.

5.2.1.4 Dismantle the 4 screws of the battery module's front face.

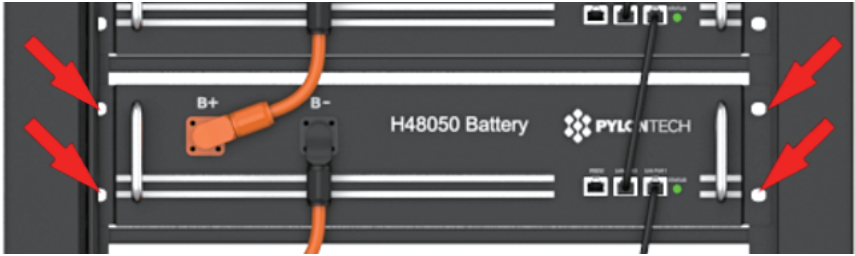

5.2.1.5 Handle the battery module out of the rack, and put it to the appoint place.



Warning: Single battery module is 24kg/32kg. If without handling tools must more than 1 personnel to handling with it. If install in high place of the rack it must more than 2 personnel.

5.2.1.6 Install the new battery module (see before 5.2.1.1). And connect the cables. Refer to chapter 3.6.

5.2.1.7 Turn on this battery string. Refer to chapter 3.7.

5.2.2.Replacement of Control module

5.2.1.1 Turn off the whole battery string's power. Must confirm the D+ and D- terminal are without power. The turn off progress refer to chapter 3.8

5.2.2.2 Pull out the plugs of Power Cables and the communication plugs.

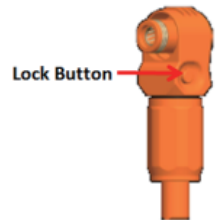
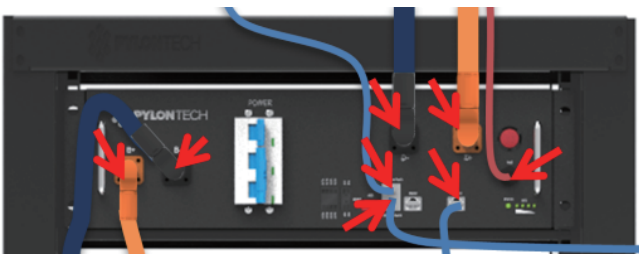

Danger: the power cables still have high voltage DC power from another battery module, must be careful to handle the Power plugs.

5.2.2.3 Dismantle the 4 screws of the battery module's front face.



5.2.2.4 Install the new control module (BMS). And reconnect all the cables. Refer to chapter 3.5.

5.2.2.5 Turn on this battery string. Refer to chapter 3.6.



Caution: Before pull out the communication cables must mark the cable number, to avoid cable wrong sequence.

5.3. Battery Maintenance



Danger: The maintenance of battery must be done by qualified and authorized person only.

Danger: Some maintenance items must shut off at first.

5.3.1. Voltage Inspection

[**Periodical Maintenance**] Check the voltage of battery system through the monitor system. Check the system abnormal voltage or not. For example: Single cell's voltage is abnormal high or low.

5.3.2. SOC Inspection

[**Periodical Maintenance**] Check the SOC of battery system through the monitor system. Check the battery string abnormal SOC or not.

5.3.3. Cables Inspection

[**Periodical Maintenance**] Visual inspect all the cables of battery system. Check the cables has broken, aging, getting loose or not.

5.3.4. Balancing

[**Periodical Maintenance**] The battery strings will become unbalance if long time not be full charged. Solution: every 3 months should do the balancing maintenance (charge to full), normally it will be done automatically by the communication between system and external device.

5.3.5. Output Relay Inspection

[Periodical Maintenance] Under low load condition (low current), control the output relay OFF and ON to hear the relay has click voice, that's mean this relay can off and on normally.

5.3.6. History Inspection

[Periodical Maintenance] Analysis the history record to check has accident (alarm and protection) or not, and analysis its reason.

5.3.7. Shutdown and Maintenance

[Periodical Maintenance] Some system function must be maintenance during the EMS restart, it is recommended to maintenance the system every 6 months.

5.3.8. Recycle

Note

Damaged batteries may leak electrolyte or produce flammable gas.

In case a damaged battery needs recycling, it shall follow the local recycling regulation (i.e. Regulation (EC) N° 1013/2006 among European Union) to process, and using the best available techniques to achieve a relevant recycling efficiency.

6. Remarks

6.1. Storage

For long-term storage (more than 3 months), the battery cells should be stored in the temperature range of 5~45°C, relative humidity <65% and contains no corrosive gas environment.

The battery module should be shelved in range of 5~45°C, dry, clean and well ventilated environment. Before storage the battery should be charged to 50~55% SoC;

It is recommended to active the chemical (discharge and charge) of the battery every 3 months, and the longest discharge and charge interval shall not exceed 6 months.



Caution: If not follow the above instructions for long term store the battery, the cycle life will have relative heavily reduction.

6.2. Capacity expansion

A new battery module can be added onto an existing system at any time. Please make sure the existing system is being fully charged before added on a new module. In a serial connection system, the new module, even with a higher SOH, shall follow the system worst SOH condition module to perform.

7. Shipment

Single module is pre-charged to ~100%SOC, or according to customer requirement, before the shipment. The remaining battery capacity after delivered on-site, is determined by the storage time and condition.

1. The battery modules should meet the UN38.3 certificate standard.
2. In particular, local rules and policy for the product transportation shall be complied with. For more details, please enquiry the Safety Data Sheet (SDS) from Pylontech for more information.

Annex 1: Installation and System Turn ON Progress List

Tick after completion	No.	Item	Remark
<input type="checkbox"/>	1	The environment is meeting all technical requirements. 3.3.1 Cleaning 3.3.2 Temperature 3.3.3 Radiating System 3.3.4 Heating System 3.3.5 Grounding System	Refer to chapter 3.3
<input type="checkbox"/>	2	Battery rack is installed follow the technical requirements.	Refer to chapter 3.5.2.
<input type="checkbox"/>	3	Control Module (BMS) and Battery Module are installed well.	Refer to chapter 3.5.3. and 3.5.4
<input type="checkbox"/>	4	Connect External Power Cable +/- between each BMS to the PCS or DC-bus distribution cabinet.	Refer to chapter 3.6.3.
<input type="checkbox"/>	5	Connect internal power cables of each battery string.	Refer to chapter 3.6.3.
<input type="checkbox"/>	6	Connect internal communication cables of each battery string.	Refer to chapter 3.6.3.
<input type="checkbox"/>	7	Set up ADD switch of every BMS (Address Assignment for Master and slave control).	Refer to chapter 3.6.4.
<input type="checkbox"/>	8	Connect external communication cables from BMS to BMS, BMS to inverter or upper controller, or another.	Refer to chapter 3.6.4.
<input type="checkbox"/>	9	Double check every power cables, communication cables installed well. And ADD Switches are setting right.	Refer to chapter 3.6.3. and 3.6.4.
<input type="checkbox"/>	10	Switch the external power or PCS on, to sure all the power equipments can work normally.	Refer to chapter 3.7
<input type="checkbox"/>	11	Turn the BMS (Battery Control Modules) of each battery string on (from 1st BMS to the last, one by one) <ul style="list-style-type: none"> • Turn on the "Power Switch": • Turn on the "Start Button": • The battery string's system will check itself, if work normal the battery string system will go into self-check mode. If has failure during the self-check, must debug the failure then can start next step. The master control module must be turned on after other slave control modules self-check finish.	Refer to chapter 3.7

Tick after completion	No.	Item	Remark
<input type="checkbox"/>	12	The first installation should do full charging progress. After Master controller has communicated with each slave BMS, it will run parallel operation. It will begin from lowest voltage battery string to do the parallel operation during the charging. If the status LED of BMS turns to green, it means this battery string is in parallel operation.	The first installation should do full charging progress.
<input type="checkbox"/>	13	If the system need black start, long press the start button 30 seconds after power on. System will close relays and output for 10 minutes.	Refer to chapter 3.7

Annex 2: System Turn OFF Progress List

Tick after completion	No.	Item	Remark
<input type="checkbox"/>	1	Soft-off the PCS through PCS's control panel.	Refer to chapter 3.8
<input type="checkbox"/>	2	Turn off the switch between PCS and this battery string (PowerCube-H1/H2-V2), or turn off the power switch of PCS, to make sure no current through this battery string.	Refer to chapter 3.8
<input type="checkbox"/>	3	Turn off all the "Power Switch" of the Control Module.	Refer to chapter 3.8



PYLONTECH

Pylon Technologies Co., Ltd.

No. 73, Lane 887, ZuChongzhi Road, Zhangjiang Hi-Tech Park
Pudong, Shanghai 201203, China

T+86-21-51317699 | **F** +86-21-51317698

Eservice@pylontech.com.cn

[Wwww.pylontech.com.cn](http://www.pylontech.com.cn)